

Madhya Pradesh

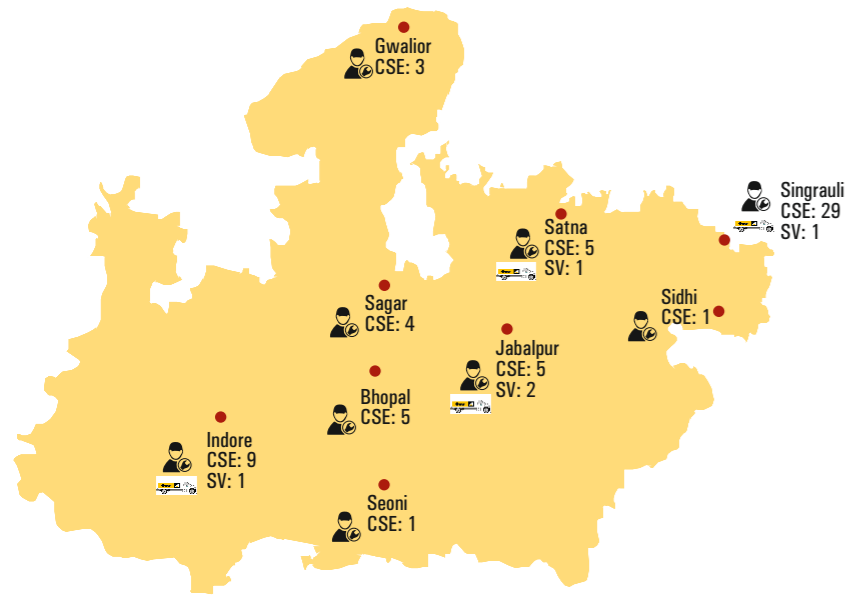

Chhattisgarh

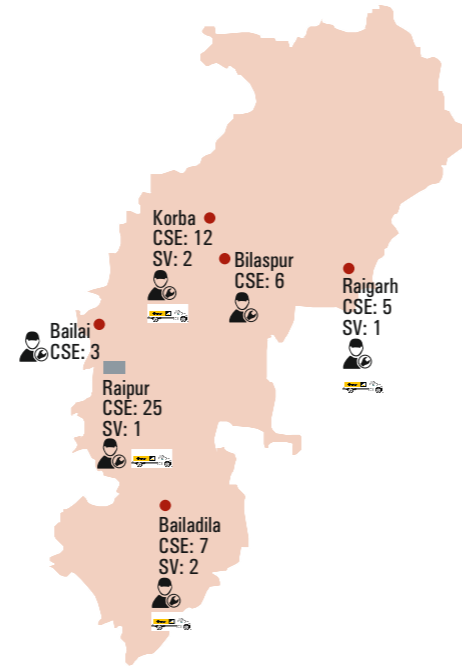

- Area Office: 23
- No of CSE : 96
- Service Vehicle: 13

- SBU HQ
- Area Office: 7
- No of CSE : 58
- Service Vehicle: 7

Gmmco Limited
 First Floor, Alaska Corporate
 Jivan Vihar Colony, Telibandha
 Raipur - 492 006
 Chattisgarh
 Phone: 0771 4285150
 Telefax: 0771 4285178
 Email: sales@gmmcoindia.com

To learn more, visit: www.cat.com/320d2-india
www.gmmco.in



CAT® 320D2
 Hydraulic Excavator
 Excellent Reliability.
 Low Fuel Consumption.

BUILT FOR IT.

Engine		
Engine Model	Cat® C7.1	
Engine Power (ISO 14396)	104 kW	139 hp
Net Power (SAE J1349/ISO 9249)	98 kW	131 hp

Weights			
Operating Weight – Std. Undercarriage	21,040 kg	46,390 lb-	
	21,690 kg	47,820 lb	
Operating Weight – Long Undercarriage	21,680 kg	47,800 lb-	
	22,390 kg	49,360 lb	





CATERPILLAR THIRUVALLUR PLANT

Building on the solid performance of its 320D predecessor, the new 320D Series 2 Hydraulic Excavator is an exceptionally reliable, highly productive machine that lowers operating costs through reduced fuel consumption and simplified routine maintenance. The 320D Series 2 machine features a new engine, powerful hydraulic system, durable main structures and a refined operator station.

Customized for the Indian market, the Cat 320D Series 2 Hydraulic Excavator is packed with exclusive features. This technologically advanced machinery has Web based Asset Management which lets the customer efficiently monitor the machine. Fuel efficiency helps cut down on running costs and also the damage being done to mother earth. With high-levels of safety and an ergonomically designed operator cabin, it ensures a perfect working condition. The Cat 320D Series 2 Hydraulic Excavator is built to last. Coupled with the ease of service and availability of spare parts, it provides customers with a hassle free environment. Highly responsive hydraulics and unmatched productivity ensures optimum outcome for the owners. The lowest lifecycle cost gets the customers the benefits of saving on more energy and costs. All these salient features built into the Cat 320D Series 2 Hydraulic Excavator in India itself, at the Cat Thiruvallur manufacturing facility.

Spread across an area of 183.5 acres, this facility has a proven track record of providing reliable world class products to the same rigorous standards of any Caterpillar facility around the world. The Caterpillar facility at Thiruvallur achieved a 6 Sigma status in 2002, and by 2006, it had procured the MQ12005 Certification. Being a key player in Caterpillar's worldwide manufacturing footprint, it is producing global standards to successfully meet local needs. Upholding Caterpillar's tradition of quality as a yardstick, the Thiruvallur facility has ensured that the development processes and design of the Cat® 320D Series 2 Hydraulic Excavators make them the best in their class, unmatched in quality and performance. The facility always guarantees world-class products.

Not only does the Cat Thiruvallur plant have world-class technology but also the skill. With a highly skilled team on the job, every machine is ensured to be perfect. Constant training at the education centre helps their people to upgrade their skill-sets and enhance the knowledge needed to deliver the best, every time. With the Cat® 320D Series 2 Hydraulic Excavator which is highly fuel efficient and best in its class with optimum productivity, the customers benefit with low costs and increased output. Also, easy availability and convenience of after-sales service further helps the customer with saving costs.

FEATURES

FUEL EFFICIENT

- Burns less, Produces More
- Flexible Fuel Modes
- Automatic Engine Idle Control
- Cross-Sensing Hydraulics
- Boom & Stick regeneration

UNMATCHED PRODUCTIVITY

- Perfectly matched, Caterpillar® designed components
- Higher digging forces and faster cycles
- Enhanced bucket size
- Best in class Pilot Hydraulics
- Highest operator efficiency

BUILT TO LAST

- HD Boom, Stick and Tracks
- Less sensitive to low quality fuel
- Sealed & grease lubricated tracks

SAFETY

- Ground level emergency shut-off
- Anti-slip platforms
- Firewall separation

PRODUCT LINK™

- Remote asset management
- Timely maintenance management

EASY MAINTENANCE

- Ground level accesses
- S•O•SSM & Pressure Ports
- Extended service intervals
- Maintenance free battery

320D2 FEATURES

Performance

- Powerful, efficient Cat® C7.1 mechanical engine with reduced fuel consumption
- Low pressure fuel system allows the engine to be more robust in areas with low quality fuel
- Caterpillar built, highly efficient hydraulic pumps deliver superior power for best in class performance
- Economy mode offers 15% lower fuel consumption with no loss in lifting and digging forces
- Boom and stick regeneration reduces fuel consumption
- 15% more fuel efficient*

Versatility

- Multiple front linkage configurations developed to meet all application needs
- Multiple auxiliary hydraulic options meet all application needs
- Cat buckets and tips are designed and matched to optimize the machine's performance
- Multiple hydro-mechanical quick couplers and work tools are offered

Reliability/Durability

- Typically the largest structures in the industry
- Modified X-frame structure provides long life & durability
- Robotically welded heavy duty boom and stick are standard
- Grease and Lubricated Tracks (GLT) provides longer life

Safety

- "Safely Home Everyday with a Cat Excavator"
- Hydraulic activation lever safely locks out all hydraulic functions
- Anti-Skid plating & countersunk bolts reduce slipping in severe conditions during routine checks
- Full length firewall separates the pump compartment from the engine
- Ground level fuel cut off switch shuts down the engine in an emergency

Ease of Operation

- Ergonomically designed cab with easy to operate controls
- Multiple seat and joystick adjustment options enhance comfort
- Excellent work site visibility from the cab enhances productivity and safety
- Optimized low effort joystick controls reduces operator fatigue
- Automatic climate control system with 10 vents maximizes comfort

Serviceability

- Most service locations can be accessed at ground level
- Extended service intervals lower owning and operating costs
- Remote mounted filters reduce the time taken to service the machine
- Pressure taps and S.O.SSM ports help maximize uptime

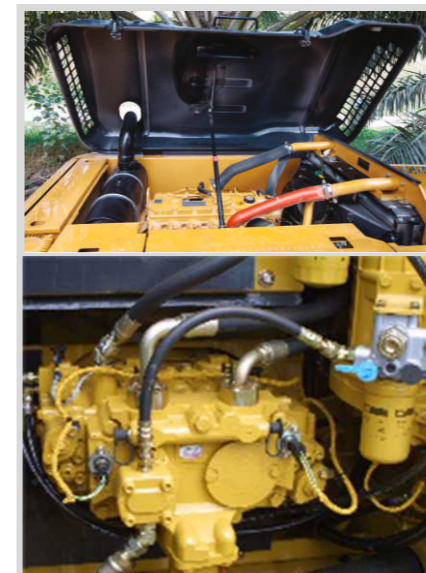

A powerful C7.1 engine

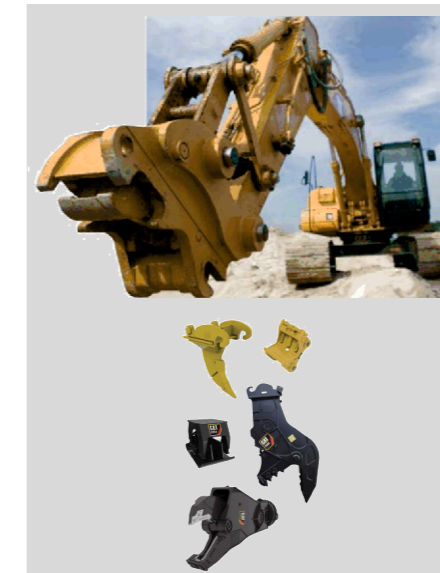

Quick couplers allow one person to change work tools in seconds for maximum performance and flexibility on a job site.



All switches and controls are intuitive and easily accessible

*Conditions apply

320D SERIES 2 SPECIFICATIONS

Engine

Engine Model	Cat® C7.1	
Engine Power - ISO 14396	104 kW	139 hp
Net Power - SAE J1349/ISO 9249	98 kW	131 hp
Bore	105 mm	4.1 in
Stroke	135 mm	5.3 in
Displacement	7.01 L	428 in ³

- The Cat C7.1 meets exhaust emissions equivalent to U.S. EPA Tier 2, EU Stage II, and China Tier 2 emission regulations.
- Net power advertised is the power available at the flywheel when the engine is equipped with fan, air cleaner, muffler and alternator.
- The field-proven C7.1 engine can work efficiently at altitudes up to 4000 m (13,120')

Weights

Operating Weight (ISO 6016)		
Standard Undercarriage		
Minimum Operating Weight*	21143 kg	46620 lb

*5.7 m (18'8") HD Reach Boom, R2.5B1 m (8'2") HD Stick, 600 mm (24") HD Triple Grouser Track Shoes, Bucket 1.14 m³ GD

Swing Mechanism

Swing Speed	10.9 rpm	10.9 rpm
Swing Torque	61.8 kN.m	45,581 lbf-ft

Drive

Maximum Travel Speed	5.4 km/h	3.3 mph
Maximum Drawbar Pull	205 kN	46,086 lbf

Hydraulic System

Main System - Maximum Flow (Total)	404 L/min	106.72 gal/min
Swing System - Maximum Flow	202 L/min	53.36 gal/min
Maximum Pressure - Equipment	35 000 kPa	5,076 psi
Maximum Pressure - Travel	35 000 kPa	5,076 psi
Maximum Pressure - Swing	25 000 kPa	3,626 psi
Pilot System - Maximum Flow	32.4 L/min	1,977 in ³ /min
Pilot System - Maximum Pressure	3900 kPa	566 psi
Boom Cylinder - Bore	120 mm	4.7 in
Boom Cylinder - Stroke	1260 mm	49.6 in
Stick Cylinder - Bore	140 mm	5.5 in
Stick Cylinder - Stroke	1504 mm	59.2 in
B1 Bucket Cylinder - Bore	120 mm	4.7 in
B1 Bucket Cylinder - Stroke	1104 mm	43.5 in

Service Refill Capacities & Change Intervals*

Fuel Tank Capacity	410 L	108.3 gal	NA
Cooling System	28 L	7.4 gal	6000 Hrs
Engine Oil (with filter)	18 L	4.8 gal	500 Hrs
Swing Drive (each)	8 L	2.1 gal	1000 Hrs
Final Drive (each)	8 L	2.1 gal	2000 Hrs
Hydraulic System (including tank)	260 L	68.7 gal	NA
Hydraulic Tank	120 L	31.7 gal	6000 Hrs

*Change Intervals are subject to periodic S•O•S & following of Standard Maintenance Procedures

Working Ranges – Reach Boom 5.7 m (18'8") HD, R2.5B1 m (8'2") Stick, Track Shoes 600 mm (24")

All dimensions are approximate.

Reach Boom 5.7 m (18'8") HD, R2.5B1 m (8'2") Stick, Track Shoes 600 mm (24")		
1 Maximum	Digging Depth	6240 mm (20'6")
2 Maximum	Reach at Ground Level	9400 mm (30'10")
3 Maximum	Cutting Height	9240 mm (30'4")
4 Maximum	Loading Height	6360 mm (20'10")
6 Maximum	Depth Cut for 2440 mm (8'0") Level Bottom	6040 mm (19'10")
7 Maximum	Vertical Wall Digging Depth	3310 mm (10'10")
Bucket	Type	GD
	Capacity	1.0 m ³ (1.4 yd ³)
	Tip Radius	1487 mm (4'11")

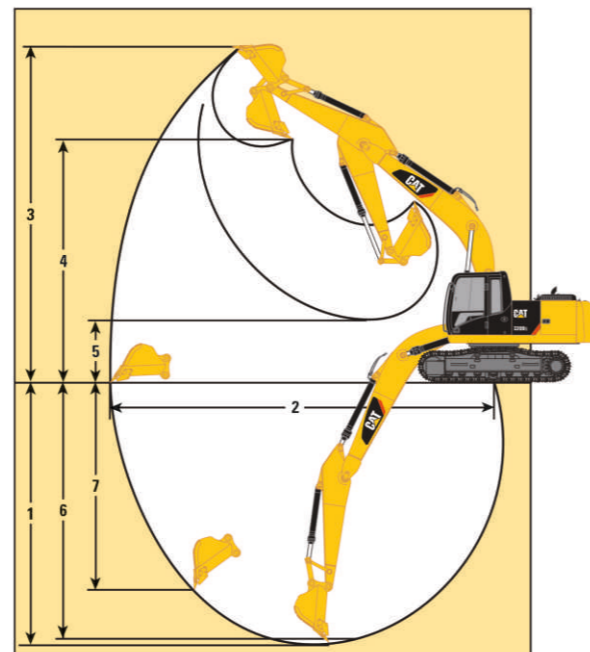

Dimensions – Reach Boom 5.7 m (18'8") HD, R2.5B1 m (8'2") Stick, Track Shoes 600 mm (24")

All dimensions are approximate.

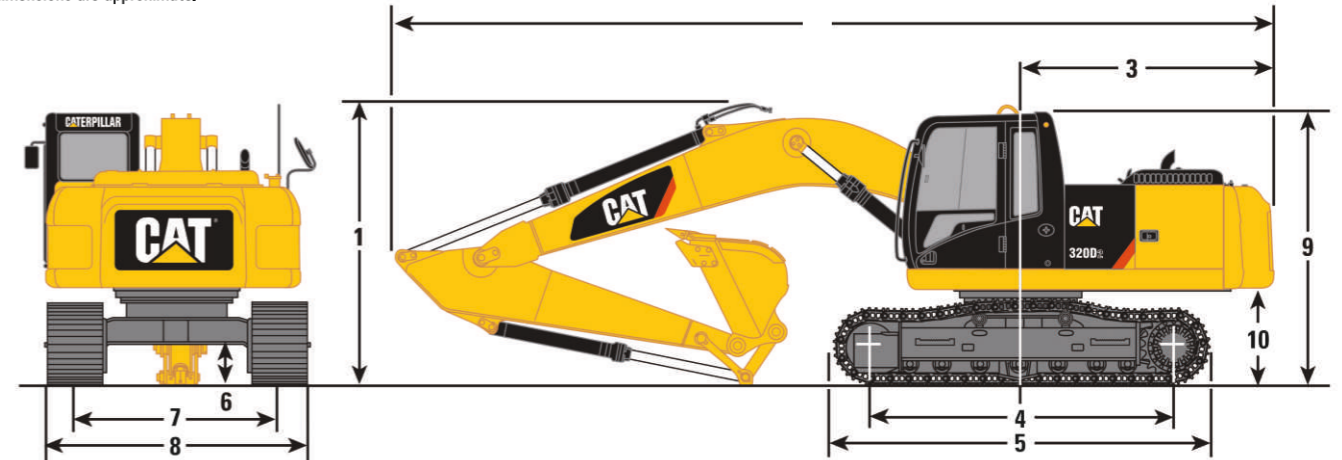

Reach Boom 5.7 m (18'8") HD, R2.5B1 m (8'2") Stick, Track Shoes 600 mm (24")

1 Shipping Height*	3050 mm (10'0")	6 Ground Clearance	450 mm (1'6")
2 Shipping Length	9460 mm (31'0")	7 Track Gauge	2200 mm (7'3")
3 Tail Swing Radius	2750 mm (9'0")	8 Transport Width	2800 mm (9'2")
4 Length to Center of Rollers	3270 mm (10'9")	9 Cab Height	2950 mm (9'8")
5 Track Length	4080 mm (13'5")	10 Counterweight Clearance**	1020 mm (3'4")

320D Series 2 Heavy Duty Reach Boom Lift Capacities – Standard Undercarriage

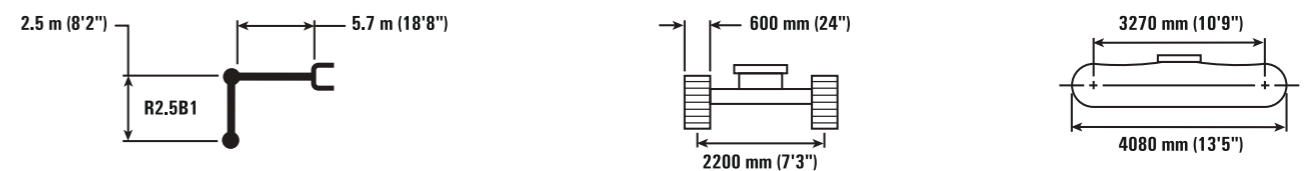

Reach Boom Length	1.5 m/5.0 ft		3.0 m/10.0 ft		4.5 m/15.0 ft		6.0 m/20.0 ft		7.5 m/25.0 ft		m		ft
	kg	lb	kg	lb	kg	lb	kg	lb	kg	lb	kg	lb	
7.5 m 25.0 ft											*4700	*4700	5.59
6.0 m 20.0 ft							*5200	4550			*4300	3600	6.83
4.5 m 15.0 ft					*6600	*6600	*5650	4400	4550	3050	*4200	3000	7.57
3.0 m 10.0 ft					*8250	6250	6250	4150	4450	2950	4050	2650	7.96
1.5 m 5.0 ft					19,850	12,400	12,850	8,350	9,250	6,050	8,550	5,600	26.41
0.0 m 0.0 ft					8950	5500	5800	3700	4250	2750	3950	2600	7.86
-1.5 m -5.0 ft			*11 300	10 450	8900	5450	5750	3650			4350	2850	7.35
			*25,700	22,300	19,150	11,750	12,350	7,900			9,600	6,200	24.08
-3.0 m -10.0 ft			*12 800	10 650	9050	5550	5850	3750			5300	3400	6.46
			*27,700	22,800	19,400	12,000	12,550	8,100			11,700	7,600	21.08
-4.5 m -15.0 ft			*6900	5850	*6900	5850					*5950	5100	4.98
			*14,400	12,650	*14,400	12,650					*13,050	11,600	16.03



ISO 10567



* Indicates that the load is limited by hydraulic lifting capacity rather than tipping load. The above loads are in compliance with hydraulic excavator lift capacity standard ISO 10567:2007. They do not exceed 87% of hydraulic lifting capacity or 75% of tipping load. Weight of all lifting accessories must be deducted from the above lifting capacities. Lifting capacities are based on the machine standing on a firm, uniform supporting surface. The use of a work tool attachment point to handle/lift objects, could affect the machine lift performance.

Lift capacity stays with ±5% for all available track shoes.

Always refer to the appropriate Operation and Maintenance Manual for specific product information.

Cat AccuGrade® Grade Control System For Hydraulic Excavators

WORK CONFIDENTLY. STAY ON GRADE.
Do it once. Do it right. All day. Every day.

Excavate with greater accuracy and control using AccuGrade technology solutions for hydraulic excavators. In-cab guidance features allow operators to quickly excavate trenches, slopes and complex designs without traditional survey stakes.



Work Confidently with Depth and Slope Guidance Save Time. Save Materials.

Features and Benefits

The AccuGrade® system is easy to use and delivers a wide range of customer benefits.

Increase Productivity and Efficiency

- Increases productivity
- Reduces guesswork and costly rework by moving dirt right the first time
- Reduces survey costs up to 90%
- Reduces operating costs
- Extends the work day

Assists with Labor Shortage

- Reduces labor requirements and costs
- Customers can get the job done more quickly and efficiently
- Reduces need for staking and checking
- Empowers operator and improves operator confidence by delivering excavation information to the cab

Integrated into Cat Machines

- Proven, optimized on-board electronic system
- Components designed into machine to maximize reliability
- Integration into cab increases ease of use
- Cat Dealer Network provides unmatched service and support

Improves Employee Satisfaction and Retention

- In-cab display brings elevation control to the cab
- Empowers operator with real-time results
- Real-time feedback on progress increases job satisfaction, eliminates guesswork and reduces operator stress
- Improves operator skills and takes performance to the next level
- Investing in the latest technology leads to a sense of value and trust in the operator

Working Safety

- Reduces the need for ground personnel (survey stakers and checkers) on the worksite, in the vicinity of working equipment

Increases Equipment Versatility

- Provides consistency and accuracy, turning your production machine into a precision digging machine

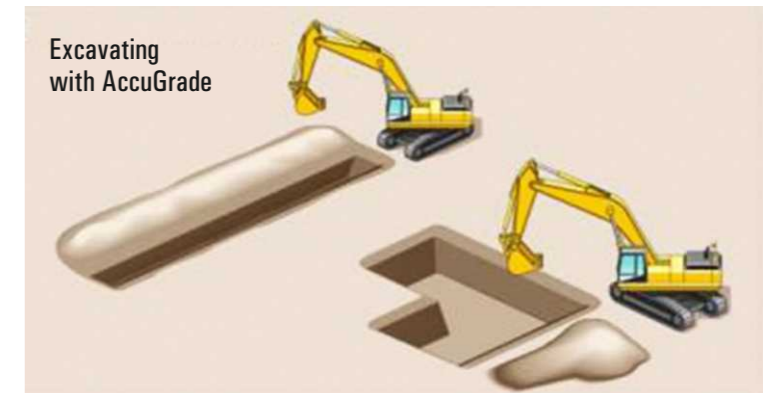

Customer Support

The AccuGrade suite of products is just one example of the Caterpillar commitment to raising the bar in the industry by making customers* work more productive and offering responsive, knowledgeable support.

Applications

JOB-READY FOR 2D APPLICATIONS

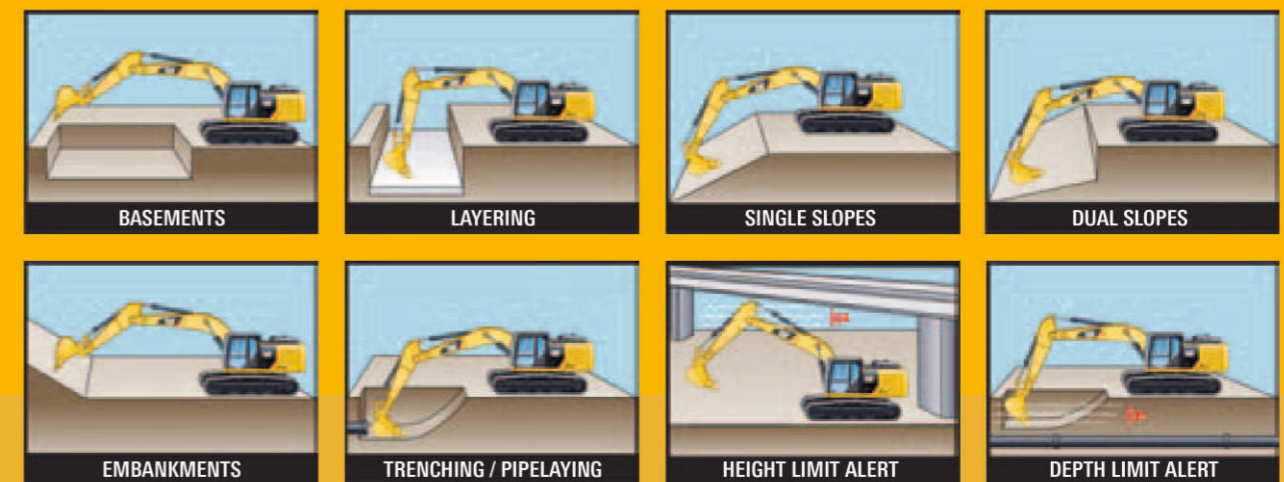

CUSTOMER SPEAK

“Caterpillar has been a trusted and reliable partner in our growth. Cat® machines have helped us to achieve faster execution of projects due to their higher productivity and excellent service support, thereby bringing in phenomenal profits. We have increased our fleet of Cat machines from 15 in 2006 to 480 in 2014.”

Devendra Jain, Director,
Dilip Buildcon Limited



What is Product Link™ / VisionLink™?

- Remote monitoring/ telematics solution
- Allows you to quickly and easily view all of your equipment, regardless of make
- Secure web-based application
- Allows insight into the operation, health and productivity of your equipment.
- Your machine's engine will provide trends on idle hours, fuel consumption, start and stop times and more while event and diagnostic codes are provided from all machine systems.
- VisionLink™ allows additional features for Cat machines through integration to other Cat data and application.

Product Link™ Offering

- Product Link™ reports key information from the machine to any location



CAT FINANCIAL

Caterpillar's Financial Products Division and Tata Capital Financial Services Limited (TCFSL), a wholly owned subsidiary of Tata Capital Limited, the financial services arm of the Tata Group, have come together to offer customers finance options for purchasing Cat equipment at all its dealership stores. Through this model, Caterpillar customers will be offered beneficial quotes and credit approval turnaround. This arrangement aims to tap eight dealer territories of Caterpillar India and benefit from the extensive network and coverage of over 100 TCFSL branch locations across the country.



WORK TOOLS

Buckets: Cat buckets and Cat Ground Engaging Tools (GET) are designed and matched to the machine to ensure optimal performance and fuel efficiency.

Utility Buckets (UD): These buckets are for digging in low-impact, low-abrasive material such as dirt, loam, and clay.

General Duty Buckets (GD): These buckets are designed for digging in low-impact, moderately abrasive materials such as dirt, loam, gravel, and clay.

Heavy Duty Buckets (HD): HD buckets are a good starting point when application conditions vary. Especially when conditions include mixed dirt, clay, sand, and gravel.

Severe Duty Buckets (SD): These buckets are best suited to highly abrasive applications such as shot rock, sand stone, and granite.



GMMCO DEALERS NETWORK



S STANDARD EQUIPMENT

- Alternator, 35 Ampere, 24 V
- Anti-slip plates
- Auto-decel
- Automatic engine warm-up system
- Batteries, 110 Ah/2 x 12 V
- Boom holding valve
- Counterweight
- Dry type air cleaner, double element
- Electric horn
- EMMS monitoring system
- Engine, Komatsu SAA6D107E-1
- Engine overheat prevention system
- Fan guard structure
- Hydraulic track adjusters (each side)
- Multi-function color monitor
- Power maximizing system
- PPC hydraulic control system
- Radiator and oil cooler dust proof net
- Rear reflector
- Rearview mirrors (RH, LH, rear, sidewise)
- ROPS cab (ISO 12117-2)
- Starting motor, 4.5 kW/24 V x 1
- Suction fan
- Track guiding guard, center section
- Track roller
 - PC200-8, 7 each side
 - PC200LC-8, 9 each side
- Track shoe
 - PC200-8, 600 mm 24" triple grouser
 - PC200LC-8, 700 mm 28" triple grouser
- Travel alarm
- Working light, 2 (boom and RH)
- Working mode selection system

***** OPTIONAL EQUIPMENT

- Additional filter system for poor-quality fuel
- Air conditioner with defroster
- Alternator, 60 Ampere, 24 V
- Arms
 - 2925 mm 9'7" arm assembly
 - 2410 mm 7'11" arm assembly
 - 1840 mm 6'0" arm assembly
- Batteries, large capacity
- Bolt-on top guard, [Operator Protective Guards level 2]
- Boom, 5700 mm 18'8"
- Cab accessories
 - Rain visor
 - Sun visor
- Cab front guard
 - Full height guard
 - Half height guard
- Heater with defroster
- Long lubricating intervals for work equipment bushing (500 hours)
- Rear view monitoring system
- Seat belt, retractable
- Seat, suspension
- Service valve
- Shoes, triple grouser
 - PC200-8: 500 mm 20", 700 mm 28", 800 mm 31.5"
 - PC200LC-8: 600 mm 24", 800 mm 31.5", 900 mm 35.5"
- Track frame undercover
- Track roller guards (full length)
- Working lights
 - 2 on cab
 - 1 on counterweight

SP SPECIAL PURPOSE BUCKET

- **Ditch cleaning bucket**
 - Capacity
 - SAE heaped **0.80 m³** 1.05 yd³
 - CECE heaped **0.70 m³** 0.92 yd³
 - Width **1800 mm** 70.9"
- **Trapezoidal bucket** is ideal for digging ditches and for drainage works
 - Capacity
 - SAE heaped **0.7 m³** 0.92 yd³
 - CECE heaped **0.5 m³** 0.65 yd³
- **Slope finishing bucket** for scraping slopes of banks
 - Capacity
 - SAE heaped **0.40 m³** 0.52 yd³
 - CECE heaped **0.35 m³** 0.46 yd³
 - Width **2000 mm** 78.7"
- **Ripper bucket** for hard and rock ground
 - Capacity
 - SAE heaped **0.62 m³** 0.81 yd³
 - CECE heaped **0.56 m³** 0.73 yd³
 - Width **990 mm** 39.0"
- **Single-shank ripper** and **three-shank ripper** are recommended for rock-digging and crushing, hard soil digging, pavement removal works, etc.

www.Komatsu.com

Printed in Japan 201205 IP.As

KOMATSU[®]

CEN00049-08

Materials and specifications are subject to change without notice.
KOMATSU[®] is a trademark of Komatsu Ltd. Japan.

KOMATSU[®]

PC200-8
PC200LC-8

HORSEPOWER
Gross: 116 kW 155 HP @ 2000 rpm
Net: 110 kW 148 HP @ 2000 rpm

OPERATING WEIGHT
PC200-8: 19400–20010 kg
 42,770–44,110 lb
PC200LC-8: 20630–21460 kg
 45,480–47,310 lb

ecot3

PC
200



Photo may include optional equipment.

HYDRAULIC EXCAVATOR

WALK-AROUND

Ecology and Economy Features

- **Low fuel consumption by total control of the engine, hydraulic and electronic system.**

Reduces fuel consumption by approx. 10%.
(Compared with the PC200-7)

- **Low emission engine**

A powerful, turbocharged and air-to-air aftercooled Komatsu SAA6D107E-1 provides **110 kW** 148 HP. This engine meets EPA Tier 3 and EU Stage 3A emissions certified, without sacrificing power or machine productivity.

- Economy mode improves fuel consumption.
- Eco-gauge for energy-saving operations
- Extended idling caution for fuel conservation

- **Low operation noise**

The dynamic noise is lowered by 2 dB compared with the PC200-7, realizing a low noise operation.

See page 4 and 5.

Safety Design

- Cab dedicated to hydraulic excavator for protecting the operator in the event of a roll over accident.
- Anti-slip plates for safe work on machine
- Safety enhancement with large side-view, sidewise, and rear mirrors added.
- Rear view monitoring system for easy checking behind the machine (optional)
- ROPS cab (ISO 12117-2)

See page 7.



Large Comfortable Cab

- Low-noise cab, similar to passenger car
- Low vibration with cab damper mounting
- Highly pressurized cab with optional air conditioner
- Operator seat and console with armrest that enables operations in the appropriate operational posture.

See pages 6.

Large TFT LCD monitor

- Easy-to-see and use 7" large multi-function color monitor
- Can be displayed in 12 languages for global support.

TFT : Thin Film Transistor
LCD : Liquid Crystal Display

See page 8.

Easy Maintenance

- Long replacement interval of engine oil, engine oil filter, and hydraulic filter
- Remote mounted engine oil filter and fuel drain valve for easy access
- Equipped with the fuel pre-filter as standard (with water separator)
- Side-by-side cooling concept enables individual cooling modules to be serviced.
- Equipped with the EMMS monitoring system

See page 9.

HORSEPOWER
Gross: 116 kW 155 HP @ 2000 rpm
Net: 110 kW 148 HP @ 2000 rpm

OPERATING WEIGHT
PC200-8: 19400 – 20010 kg
42,770 – 44,110 lb
PC200LC-8: 20630 – 21460 kg
45,480 – 47,310 lb

BUCKET CAPACITY
0.50 – 1.17 m³
0.65 – 1.53 yd³

Photo may include optional equipment.

ECOLOGY & ECONOMY FEATURES

Komatsu Technology



Komatsu develops and produces all major components, such as engines, electronics and hydraulic components, in house. With this "Komatsu Technology," and adding customer feedback, Komatsu is achieving great advancements in technology. To achieve both high levels of productivity and economical performance, Komatsu has developed the main components with a total control system. The result is a new generation of high performance and environment-friendly excavators.

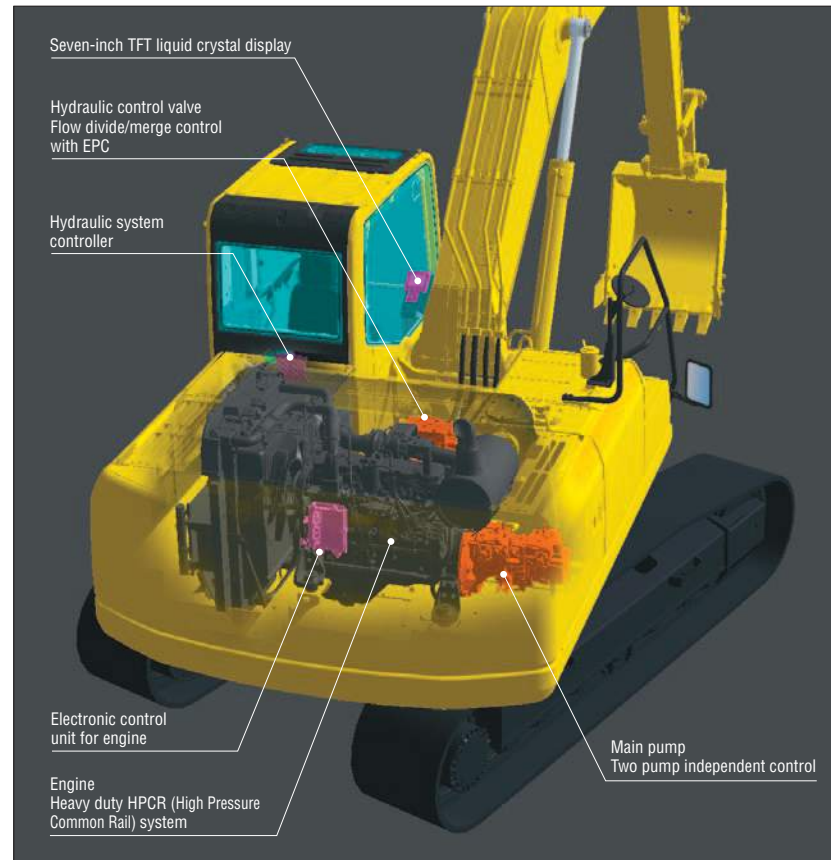

Low Fuel Consumption

The newly-developed Komatsu SAA6D107E-1 [ecot3] engine enables NOx emissions to be significantly reduced with the accurate multi-staged fuel injection by the engine controller. It improves total engine durability using the high-pressure fuel injection system developed specifically for construction machinery. This excavator significantly reduces hourly fuel consumption using the highly-efficient matching techniques of the engine and hydraulic unit and also provides features that promote energy-saving operations such as the E mode and Eco-gauge.

Fuel consumption 10% reduced

Compared with the PC200-7 at P mode and 100% working efficiency. Fuel consumption varies depending on job conditions.



Low Emission Engine

Komatsu SAA6D107E-1 meets EPA, Tier 3 and EU Stage 3A emissions certified and reduced NOx emission by 29% compared with the PC200-7.



Low Operation Noise

Enables a low noise operation using the low-noise engine and methods to cut noise at source.

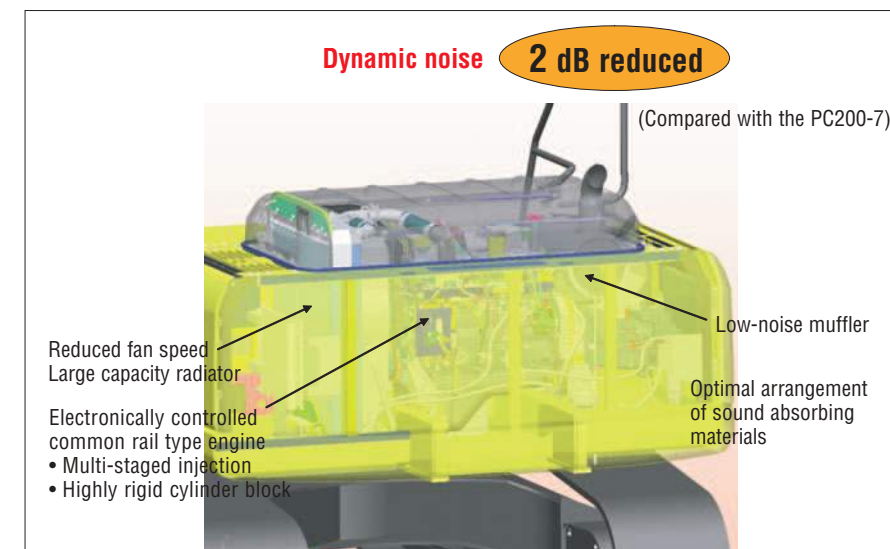

Idling Caution

To prevent unnecessary fuel consumption, an idling caution is displayed on the monitor, if the engine idles for 5 minutes or more.



Working Modes Selectable

Two established work modes are further improved.

P mode – Power or work priority mode has low fuel consumption, but fast equipment speed and maximum production and power are maintained.

E mode – Economy or fuel priority mode further reduces fuel consumption, but maintains the P-mode-like working equipment speed for light duty work.

You can select Power or Economy modes using a one-touch operation on the monitor panel depending on workloads.



- E** Fuel priority E mode
- P** Work priority P mode

Eco-gauge that Assists Energy-saving Operations

Equipped with the Eco-gauge that can be recognized at a glance on the right of the multi-function color monitor for environment-friendly energy-saving operations. Allows focus on operation in the green range with reduced CO₂ emissions and efficient fuel consumption.



Eco-gauge

WORKING ENVIRONMENT



Low Cab Noise

The newly-designed cab is highly rigid and has excellent sound absorption ability. Thorough improvement of noise source reduction and use of low noise engine, hydraulic equipment, and air conditioner allows this machine to generate a low level of noise similar to that of a passenger car.

Low Vibration with Cab Damper Mounting

PC200-8 uses viscous damper mounting for cab that incorporates longer stroke and the addition of a spring. The new cab damper mounting combined with high rigidity deck aids vibration reduction at operator seat.

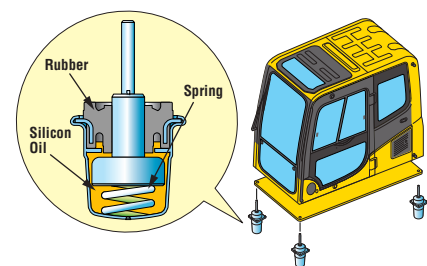

Wide Newly-designed Cab

Newly-designed wide spacious cab includes seat with reclining backrest. The seat height and longitudinal inclination are easily adjusted using a pull-up lever. You can set the appropriate operational posture of armrest together with the console. Reclining the seat further enables you to place it into the fully flat state with the headrest attached.



Pressurized Cab

Optional air conditioner, air filter and a higher internal air pressure (+6.0 mm Aq +0.2"Aq) prevent external dust from entering the cab.

Automatic Air Conditioner (optional)

Enables you to easily and precisely set cab atmosphere with the instruments on the large LCD. The bi-level control function keeps the operator's head and feet cool and warm respectively. This improved air flow function keeps the inside of the cab comfortable throughout the year. Defroster function keeps front glass clear.

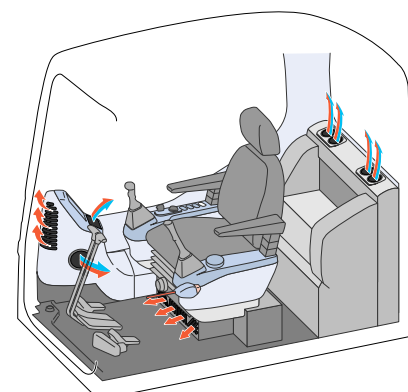

Safety Features

ROPS Cab

The machine is equipped with a ROPS cab that conforms to ISO 12117-2 for excavators as standard equipment. The ROPS cab has high shock-absorption performance, featuring excellent durability and impact strength. It also satisfies the requirements of ISO OPG top guard level 1 for falling objects. Combined with the retractable seat belt, The ROPS cab protects the operator in case of tipping over and against falling objects.



Anti-slip Plates

Highly durable anti-slip plates maintain superior traction performance for the long term.



Pump/engine Room Partition

Pump/engine room partition prevents oil from spraying onto the engine if a hydraulic hose should burst.

Lock Lever

Locks the hydraulic pressure to prevent unintentional movement. Neutral start function allows machine to be started only in lock position.



Large Side-view, Rear, and Sidewise Mirrors

Enlarged left-side mirror and addition of rear and side mirror allow the PC200-8 to meet the new ISO visibility requirements.



Rear View Monitoring System (optional)

The operator can view the rear of the machine with a color monitor screen.



Monitor for rear view camera

Thermal and Fan Guards

Thermal and fan guards are placed around high-temperature parts of the engine and fan drive.



MAINTENANCE FEATURES

Large LCD Color Monitor

Large Multi-lingual LCD Monitor

A large user-friendly color monitor enables safe, accurate and smooth work. Improved screen visibility is achieved by the use of TFT liquid crystal display that can easily be read at various angles and lighting conditions. Simple and easy to operate switches. Industry first function keys facilitate multi-function operations. Displays data in 12 languages to globally support operators around the world.



- Indicators**
- 1 Auto-decelerator
 - 2 Working mode
 - 3 Travel speed
 - 4 Engine water temperature gauge
 - 5 Hydraulic oil temperature gauge
 - 6 Fuel gauge
 - 7 Eco-gauge
 - 8 Function switches menu
- Basic operation switches**
- 1 Auto-decelerator
 - 2 Working mode selector
 - 3 Traveling selector
 - 4 Buzzer cancel
 - 5 Wiper
 - 6 Windshield washer

Mode Selection

The multi-function color monitor has Power mode, Economy mode, Lifting mode, Breaker mode and Attachment mode.

Working Mode	Application	Advantage
P	Power mode	<ul style="list-style-type: none"> Maximum production/power Fast cycle time
E	Economy mode	<ul style="list-style-type: none"> Excellent fuel economy
L	Lifting mode	<ul style="list-style-type: none"> Hydraulic pressure is increased by 7%
B	Breaker operation	<ul style="list-style-type: none"> Optimum engine rpm, hydraulic flow
ATT	Attachment mode	<ul style="list-style-type: none"> Optimum engine rpm, hydraulic flow, 2 way

Lifting Mode

When the Lifting mode is selected, lifting capacity is increased 7% by raising hydraulic pressure.

EMMS (Equipment Management Monitoring System)

Monitor Function

Controller monitors engine oil level, coolant temperature, battery charge and air clogging, etc. If controller finds any abnormality, it is displayed on the LCD.



Maintenance Function

Monitor informs replacement time of oil and filters on LCD when the replacement interval is reached.



Trouble Data Memory Function

Monitor stores abnormalities for effective troubleshooting.

Side-by-side Cooling

Since radiator, aftercooler and oil cooler are arranged in parallel, it is easy to clean, remove and install them. Radiator, aftercooler, and oil cooler made of aluminum have high cooling efficiency and are easily recycled.



Equipped with the Fuel Pre-filter (with Water Separator)

Removes water and contaminants in the fuel to prevent fuel problems. (With built-in priming pump)



Washable Cab Floor Mat

The PC200-8's cab floor mat is easy to keep clean. The gently inclined surface has a flanged floor mat and drainage holes to facilitate runoff.



Easy Access to Engine Oil Filter and Fuel Drain Valve

Engine oil filter and fuel drain valve are remote mounted to improve accessibility.



Equipped with the Eco-drain Valve as Standard.

Prevents clothes and the ground from becoming contaminated due to oil leakage when replacing the engine oil.



Large-capacity Fuel Tank and Rustproof Treatment

400-liter (106 U.S. gal) high-capacity fuel tank. Effective corrosion resistance using rust-proof treatment.

Sloping Track Frame

Prevents dirt and sand from accumulating and allows easy mud removal.

Gas Assisted Engine Hood Damper Cylinders

The engine hood can be easily opened and closed with the assistance of the gas assisted engine hood damper cylinders.



Long-life Oil, Filter

Uses high-performance filtering materials and long-life oil. Extends the oil and filter replacement interval.



Hydraulic oil filter (Eco-white element)

- Engine oil & Engine oil filter every **500** hours
- Hydraulic oil every **5000** hours
- Hydraulic oil filter every **1000** hours

Air Conditioner Filter (optional)

The air conditioner filter is removed and installed without the use of tools facilitating filter maintenance.



Internal air conditioner filter External air conditioner filter

Long Work Equipment Greasing Interval (optional)

High quality BMRC bushings and resin shims are optionally available for work equipment pins excluding bucket, extending greasing interval to 500 hours.



LIFTING CAPACITY WITH LIFTING MODE

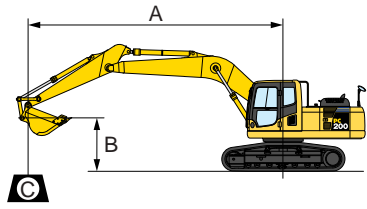

A: Reach from swing center
 B: Bucket hook height
 C: Lifting capacity
 Cf: Rating over front
 Cs: Rating over side
 ●: Rating at maximum reach

Conditions:

- 5700 mm 18'8" one-piece boom
- 0.8 m³ 1.05 yd³ SAE heaped bucket
- Shoe width:
—PC200-8 600 mm 24" triple grouser

PC200-8		Arm: 1840 mm 6'0"				Bucket: 0.8 m ³ 1.05 yd ³ SAE heaped				Shoe: 600 mm 24" triple grouser			
B	A	MAX		7.6 m 25'		6.1 m 20'		4.6 m 15'		3.0 m 10'		1.5 m 5'	
		Cf	Cs	Cf	Cs	Cf	Cs	Cf	Cs	Cf	Cs	Cf	Cs
7.6 m 25'		*4800 kg *10,600 lb	*4800 kg *10,600 lb					*5500 kg *12,100 lb	*5500 kg *12,100 lb				
6.1 m 20'		*4450 kg *9,900 lb	3450 kg 7,600 lb			*5450 kg *12,100 lb	3800 kg 8,300 lb	*5700 kg *12,600 lb	*5700 kg *12,600 lb				
4.6 m 15'		4200 kg 9,300 lb	2700 kg 6,000 lb			5650 kg 12,500 lb	3700 kg 8,100 lb	*7000 kg *15,400 lb	6000 kg 13,200 lb	*9850 kg *21,800 lb	*9850 kg *21,800 lb		
3.0 m 10'		3750 kg 8,300 lb	2350 kg 5,200 lb			5450 kg 12,000 lb	3500 kg 7,700 lb	8600 kg 19,000 lb	5350 kg 11,800 lb				
1.5 m 5'		3600 kg 8,000 lb	2250 kg 5,000 lb	3650 kg 8,100 lb	2300 kg 5,000 lb	5250 kg 11,500 lb	3300 kg 7,300 lb	8250 kg 18,200 lb	5000 kg 11,100 lb				
0 m 0'		3750 kg 8,200 lb	2300 kg 5,100 lb			5100 kg 11,200 lb	3150 kg 7,000 lb	8050 kg 17,700 lb	4850 kg 10,700 lb				
-1.5 m -5'		4200 kg 9,300 lb	2650 kg 5,800 lb			5050 kg 11,200 lb	3150 kg 6,900 lb	8050 kg 17,700 lb	4850 kg 10,700 lb	*13350 kg *29,400 lb	9500 kg 21,000 lb		
-3.0 m -10'		5500 kg 12,100 lb	3450 kg 7,600 lb					8200 kg 18,100 lb	5000 kg 11,000 lb	*13200 kg *29,100 lb	9800 kg 21,600 lb		

PC200-8		Arm: 2410 mm 7'11"				Bucket: 0.8 m ³ 1.05 yd ³ SAE heaped				Shoe: 600 mm 24" triple grouser			
B	A	MAX		7.6 m 25'		6.1 m 20'		4.6 m 15'		3.0 m 10'		1.5 m 5'	
		Cf	Cs	Cf	Cs	Cf	Cs	Cf	Cs	Cf	Cs	Cf	Cs
7.6 m 25'		*4300 kg *9,500 lb	4300 kg 9,400 lb										
6.1 m 20'		*4100 kg *9,000 lb	3000 kg 6,600 lb			*4850 kg *10,700 lb	3950 kg 8,700 lb						
4.6 m 15'		3800 kg 8,400 lb	2450 kg 5,400 lb	3900 kg 8,600 lb	2500 kg 5,600 lb	*5400 kg *11,900 lb	3800 kg 8,400 lb	*6200 kg *13,600 lb	*6200 kg *13,600 lb				
3.0 m 10'		3400 kg 7,500 lb	2150 kg 4,800 lb	3800 kg 8,400 lb	2450 kg 5,400 lb	5600 kg 12,300 lb	3600 kg 8,000 lb	*8100 kg *17,800 lb	5700 kg 12,600 lb				
1.5 m 5'		3300 kg 7,300 lb	2050 kg 4,600 lb	3700 kg 8,200 lb	2350 kg 5,200 lb	5350 kg 11,800 lb	3400 kg 7,500 lb	8450 kg 18,700 lb	5250 kg 11,500 lb				
0 m 0'		3400 kg 7,500 lb	2100 kg 4,700 lb	3650 kg 8,000 lb	2250 kg 5,000 lb	5150 kg 11,400 lb	3250 kg 7,100 lb	8150 kg 18,000 lb	4950 kg 11,000 lb	*7350 kg *16,200 lb	*7350 kg *16,200 lb		
-1.5 m -5'		3750 kg 8,300 lb	2350 kg 5,200 lb			5100 kg 11,200 lb	3150 kg 7,000 lb	8100 kg 17,800 lb	4900 kg 10,800 lb	*12250 kg *27,000 lb	9500 kg 21,000 lb	*7650 kg *16,900 lb	*7650 kg *16,900 lb
-3.0 m -10'		4650 kg 10,200 lb	2900 kg 6,400 lb			5150 kg 11,400 lb	3200 kg 7,100 lb	8200 kg 18,000 lb	4950 kg 11,000 lb	*14700 kg *32,400 lb	9750 kg 21,500 lb	*12650 kg *27,900 lb	*12650 kg *27,900 lb
-4.6 m -15'		*7200 kg *15,900 lb	4550 kg 10,000 lb					*8100 kg *17,800 lb	5200 kg 11,500 lb	*11600 kg *25,500 lb	10150 kg 22,400 lb		

PC200-8		Arm: 2925 mm 9'7"				Bucket: 0.8 m ³ 1.05 yd ³ SAE heaped				Shoe: 600 mm 24" triple grouser			
B	A	MAX		7.6 m 25'		6.1 m 20'		4.6 m 15'		3.0 m 10'		1.5 m 5'	
		Cf	Cs	Cf	Cs	Cf	Cs	Cf	Cs	Cf	Cs	Cf	Cs
7.6 m 25'		*2750 kg *6,100 lb	*2750 kg *6,100 lb			*3800 kg *8,300 lb	*3800 kg *8,300 lb						
6.1 m 20'		*2600 kg *5,800 lb	*2600 kg *5,800 lb			*4300 kg *9,500 lb	4050 kg 8,900 lb						
4.6 m 15'		*2650 kg *5,800 lb	2150 kg 4,800 lb	3950 kg 8,800 lb	2600 kg 5,700 lb	*4900 kg *10,800 lb	3900 kg 8,600 lb						
3.0 m 10'		*2800 kg *6,100 lb	1950 kg 4,300 lb	3850 kg 8,500 lb	2500 kg 5,500 lb	5650 kg 12,500 lb	3700 kg 8,100 lb	*7350 kg *16,200 lb	5850 kg 12,900 lb	*11350 kg *25,000 lb	*11350 kg *25,000 lb		
1.5 m 5'		3000 kg 6,600 lb	1850 kg 4,100 lb	3750 kg 8,300 lb	2350 kg 5,200 lb	5400 kg 11,900 lb	3450 kg 7,600 lb	8600 kg 19,000 lb	5350 kg 11,800 lb	*11200 kg *24,700 lb	*7500 kg *16,500 lb		
0 m 0'		3050 kg 6,700 lb	1900 kg 4,200 lb	3650 kg 8,000 lb	2300 kg 5,000 lb	5200 kg 11,500 lb	3250 kg 7,200 lb	8250 kg 18,200 lb	5050 kg 11,100 lb	*8000 kg *17,700 lb	*8000 kg *17,700 lb		
-1.5 m -5'		3350 kg 7,400 lb	2050 kg 4,600 lb	3600 kg 7,900 lb	2250 kg 4,900 lb	5100 kg 11,200 lb	3150 kg 7,000 lb	8100 kg 17,900 lb	4900 kg 10,800 lb	*11200 kg *24,700 lb	9500 kg 20,900 lb	*6800 kg *15,000 lb	*6800 kg *15,000 lb
-3.0 m -10'		4000 kg 8,800 lb	2500 kg 5,500 lb			5100 kg 11,200 lb	3150 kg 7,000 lb	8100 kg 17,900 lb	4950 kg 10,900 lb	*15600 kg *34,400 lb	9650 kg 21,300 lb	*10550 kg *23,200 lb	*10550 kg *23,200 lb
-4.6 m -15'		5650 kg 12,500 lb	3550 kg 7,900 lb					8300 kg 18,300 lb	5100 kg 11,200 lb	*13050 kg *28,800 lb	10000 kg 22,000 lb		

* Load is limited by hydraulic capacity rather than tipping. Ratings are based on SAE Standard No. J1097. Rated loads do not exceed 87% of hydraulic lift capacity or 75% of tipping load.



LIFTING CAPACITY WITH LIFTING MODE

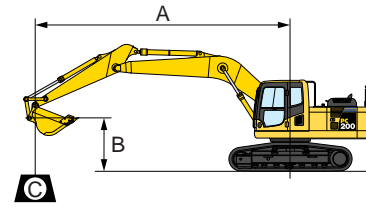

A: Reach from swing center
 B: Bucket hook height
 C: Lifting capacity
 Cf: Rating over front
 Cs: Rating over side
 ●: Rating at maximum reach

Conditions:

- 5700 mm 18'8" one-piece boom
- 0.8 m³ 1.05 yd³ SAE heaped bucket
- Shoe width:
—PC200LC-8 700 mm 28" triple grouser

PC200LC-8		Arm: 1840 mm 6'0"				Bucket: 0.8 m ³ 1.05 yd ³ SAE heaped				Shoe: 700 mm 28" triple grouser			
B	A	MAX		7.6 m 25'		6.1 m 20'		4.6 m 15'		3.0 m 10'		1.5 m 5'	
		Cf	Cs	Cf	Cs	Cf	Cs	Cf	Cs	Cf	Cs	Cf	Cs
7.6 m 25'		*4800 kg *10,600 lb	*4800 kg *10,600 lb					*5500 kg *12,100 lb	*5500 kg *12,100 lb				
6.1 m 20'		*4450 kg *9,900 lb	3950 kg 8,800 lb			*5450 kg *12,100 lb	4350 kg 9,600 lb	*5700 kg *12,600 lb	*5700 kg *12,600 lb				
4.6 m 15'		*4500 kg *9,900 lb	3150 kg 7,000 lb			*5900 kg *13,000 lb	4250 kg 9,400 lb	*7000 kg *15,400 lb	6900 kg 15,200 lb	*9850 kg *21,800 lb	*9850 kg *21,800 lb		
3.0 m 10'		*4650 kg *10,200 lb	2800 kg 6,200 lb			*6700 kg *14,800 lb	4050 kg 9,000 lb	*8700 kg *19,200 lb	6250 kg 13,700 lb				
1.5 m 5'		4500 kg 9,900 lb	2650 kg 5,900 lb	4550 kg 10,000 lb	2700 kg 6,000 lb	6500 kg 14,300 lb	3850 kg 8,500 lb	*10350 kg *22,800 lb	5900 kg 13,000 lb				
0 m 0'		4650 kg 10,300 lb	2750 kg 6,100 lb			6350 kg 14,000 lb	3750 kg 8,200 lb	10200 kg 22,500 lb	5700 kg 12,600 lb				
-1.5 m -5'		5250 kg 11,600 lb	3100 kg 6,900 lb			6350 kg 14,000 lb	3700 kg 8,200 lb	10200 kg 22,500 lb	5700 kg 12,600 lb	*13350 kg *29,400 lb	11350 kg 25,100 lb		
-3.0 m -10'		6850 kg 15,100 lb	4050 kg 8,900 lb					*9550 kg *21,100 lb	5900 kg 13,000 lb	*13200 kg *29,100 lb	11700 kg 25,800 lb		

PC200LC-8		Arm: 2410 mm 7'11"				Bucket: 0.8 m ³ 1.05 yd ³ SAE heaped				Shoe: 700 mm 28" triple grouser			
B	A	MAX		7.6 m 25'		6.1 m 20'		4.6 m 15'		3.0 m 10'		1.5 m 5'	
		Cf	Cs	Cf	Cs	Cf	Cs	Cf	Cs	Cf	Cs	Cf	Cs
7.6 m 25'		*4300 kg *9,500 lb	*4300 kg *9,500 lb										
6.1 m 20'		*4100 kg *9,000 lb	3500 kg 7,700 lb			*4850 kg *10,700 lb	4500 kg 10,000 lb						
4.6 m 15'		*4150 kg *9,100 lb	2850 kg 6,300 lb	*4700 kg *10,400 lb	2950 kg 6,500 lb	*5400 kg *11,900 lb	4400 kg 9,700 lb	*6200 kg *13,600 lb	*6200 kg *13,600 lb				
3.0 m 10'		*4250 kg *9,300 lb	2550 kg 5,600 lb	4700 kg 10,400 lb	2850 kg 6,300 lb	*6300 kg *13,900 lb	4200 kg 9,200 lb	*8100 kg *17,800 lb	6600 kg 14,600 lb				
1.5 m 5'		4100 kg 9,000 lb	2450 kg 5,400 lb	4600 kg 10,200 lb	2750 kg 6,100 lb	*6600 kg *14,500 lb	3950 kg 8,700 lb	*9850 kg *21,800 lb	6100 kg 13,500 lb				
0 m 0'		4200 kg 9,300 lb	2500 kg 5,500 lb	4550 kg 10,000 lb	2700 kg 5,900 lb	6450 kg 14,200 lb	3800 kg 8,400 lb	10350 kg 22,800 lb	5850 kg 12,900 lb	*7350 kg *16,200 lb	*7350 kg *16,200 lb		
-1.5 m -5'		4650 kg 10,300 lb	2750 kg 6,100 lb			6350 kg 14,000 lb	3750 kg 8,300 lb	10250 kg 22,600 lb	5800 kg 12,700 lb	*12250 kg *27,000 lb	11400 kg 25,100 lb	*7650 kg *16,900 lb	*7650 kg *16,900 lb
-3.0 m -10'		5750 kg 12,700 lb	3450 kg 7,600 lb			6400 kg 14,200 lb	3800 kg 8,400 lb	*10250 kg *22,600 lb	5850 kg 12,900 lb	*14700 kg *32,400 lb	11600 kg 25,600 lb	*12650 kg *27,900 lb	*12650 kg *27,900 lb
-4.6 m -15'		*7200 kg *15,900 lb	5300 kg 11,700 lb					*11600 kg *25,500 lb	6100 kg 13,500 lb	*11600 kg *25,500 lb	11900 kg 26,200 lb		

PC200LC-8		Arm: 2925 mm 9'7"				Bucket: 0.8 m ³ 1.05 yd ³ SAE heaped				Shoe: 700 mm 28" triple grouser			
B	A	MAX		7.6 m 25'		6.1 m 20'		4.6 m 15'		3.0 m 10'		1.5 m 5'	
		Cf	Cs	Cf	Cs	Cf	Cs	Cf	Cs	Cf	Cs	Cf	Cs
7.6 m 25'		*2750 kg *6,100 lb	*2750 kg *6,100 lb			*3800 kg *8,300 lb	*3800 kg *8,300 lb						
6.1 m 20'		*2600 kg *5,800 lb	*2600 kg *5,800 lb			*4300 kg *9,500 lb	*4300 kg *9,500 lb						
4.6 m 15'		*2650 kg *5,800 lb	2550 kg 5,600 lb	*4650 kg *10,300 lb	3000 kg 6,600 lb	*4900 kg *10,800 lb	4500 kg 9,900 lb						
3.0 m 10'		*2800 kg *6,100 lb	2300 kg 5,100 lb	4750 kg 10,500 lb	2900 kg 6,400 lb	*5850 kg *12,900 lb	4250 kg 9,400 lb	*7350 kg *16,200 lb	6750 kg 14,900 lb	*11350 kg *25,000 lb	*11350 kg *25,000 lb		
1.5 m 5'		*3050 kg *6,700 lb	2200 kg 4,900 lb	4650 kg 10,200 lb	2800 kg 6,200 lb	6700 kg 14,700 lb	4000 kg 8,900 lb	*9300 kg *20,500 lb	6250 kg 13,800 lb	*7500 kg *16,500 lb	*7500 kg *16,500 lb		